

Dock leveler

Crawford DL6111SA

ASSA ABLOY

ASSA ABLOY Entrance Systems

The global leader in
door opening solutions



Hydraulic swing lip dock leveller

Crawford DL6111SA swingdock autodock has a self-supporting frame for easy integration with a building. It forms a base for a complete loadhouse outside the building, containing all relevant components, leveler, shelter and door to make it a total docking solution. It is a heavy-duty dock leveler with a load capacity of 100 kN or optional 150 kN. Robust and reliable construction guarantees high performance during the tough handling of high loads

To enable a safe and efficient process for loading and unloading, the Crawford DL6111SA Swingdock connects the building with the vehicle. The result is highest safety for the transfer of goods, avoiding injuries to the personal or damages to the equipment. It is a time saving solution securing shortest possible ways in and out of the warehouse.

The Crawford DL6111SA Swingdock:

- Preventive maintenance is easy and fast to secure functionality and avoid downtimes.
- Bent swing lip prevents material handling equipment from "grounding out".
- Robust and reliable construction to guarantee high performance during the tough handling of high loads.

ASSA ABLOY 950 series - the intelligent, all in one, docking control system

The innovative and unique 950 series docking control system gives you direct control of the dock leveler, dock shelter and door all in one control unit. With only a few self explaining buttons it is easy to operate, to meet the demands of modern logistics. Separate steering units or complex wiring are no longer needed.

ASSA ABLOY DE6090DI Dock-IN

ASSA ABLOY Dock-IN is the world's first combined solution with parking guide and traffic lights in one system. ASSA ABLOY Dock-IN ensures a safe and secure dock in procedure with the help of white guiding lights and red traffic lights. There is no need to paint and repaint guiding lines on the asphalt or install conventional steel parking guides, which are an obstacle in the yard. With modern LED technology ASSA ABLOY Dock-IN has a low energy consumption and a long life.

Technical Data

Nominal length 100 kN ¹	2000, 2450, 3000 mm
Normal width AD	3300, 3500, 3600, 3750 mm
Leveler width	2000, 2200 mm
Load capacity	100 kN (10 tonnes) 150 kN (15 tonnes)
Vertical working range 100 kN	
Rise above dock	up to 410 mm
Fall below dock	down to 310 mm
Vertical working range 150 kN	
Rise above dock	up to 390 mm
Fall below dock	down to 340 mm
Platform tear-plate thickness 100 kN	8/10 mm
Platform tear-plate thickness 150 kN	10/12 mm
Max. point load leveler platform	6,5 N / mm ² (8 mm tear-plate & 10 mm tear-plate)
Lip material & length	steel, 500 mm
Control unit protection class	IP 54
Nominal voltage	400V 3-phase 230V 3-phase
Nominal motor power	1,5 kW
European standard	EN 1398 Dock levelers
1) Other sizes on request	

Dimensions

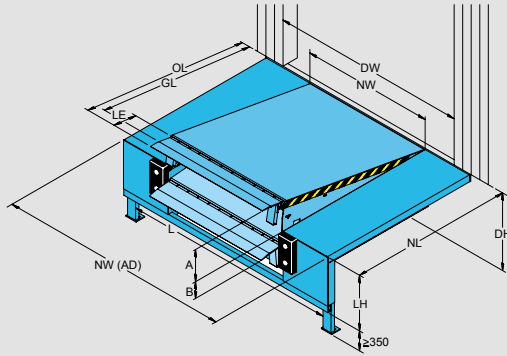

Platform thickness	
Thickness	Max. point load
8 mm	6,5 N / mm ²
10 mm	6,5 N / mm ²

Dimensions				Vertical working range	
				A	B
NL	OL	GL	LH	A	B
2000	NL+350	NL+200	800	270	310
2450	NL+350	NL+200	800	360	300
3000	NL+350	NL+200	800	10	300

Nominal width (NW) 2000, 2200
Nominal width NW (AD) 3300, 3500, 3600, 3750

NL	Nominal length
OL	Overall length
GL	Gradient length
NW	Nominal width
LE	Leveler extension
LH	Leveler height
A	Working range above dock level
B	Working range below dock level
DH	Dock height
DW	Door width
NW (AD)	Nominal width Autodock (incl. side tread panels)
L	Distance between plinths
OW (AD)	Overall width Autodock = NW (AD) - 20

Electrical preparations

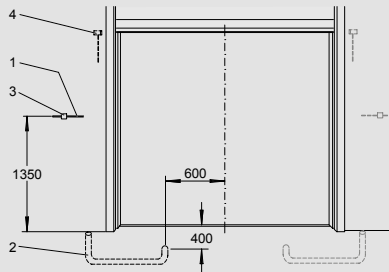

1	Control unit (included in the delivery)
2	Conduit for wiring internal diameter 70, angles <45° (by others)
3	Mains supply: 3 / N / PE AC 50 Hz 230 / 400V Mains fuse: D0 10 A gL Motor power: 1,5 kW
4	Cable: 7 x 0,75 mm ²
5	Motor cable: 4 x 1,5 mm ²
6	Optional safety switch on sectional door to disable leveler when door is closed*

*Non standard

Operating functions for swing lip levelers

950 L SD / 950 LA SD



950 DL SD / 950 DLA SD



950 LS SD / 950 LSA SD



950 DLS SD / 950 DLSA SD





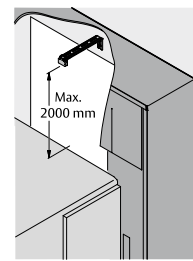
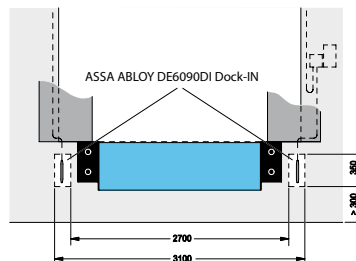
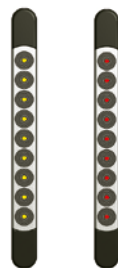

SD = Swingdock
L = Leveler
A = Auto Button
D = Door
S = Shelter

ASSA ABLOY DE6090DI Dock-IN



Standard available colours

	Red RAL 3002		Green RAL 6005		Hot dip galvanised
	Blue RAL 5010		Jet Black RAL 9005		