

Product datasheet

Overhead sectional door

ASSA ABLOY OH1042S

ASSA ABLOY

ASSA ABLOY Entrance Systems

The global leader in
door opening solutions



Copyright and Disclaimer Notice

Although the contents of this publication have been compiled with the greatest possible care, ASSA ABLOY Entrance Systems cannot accept liability for any damage that might arise from errors or omissions in this publication. We also reserve the right to make appropriate technical modifications/replacements without prior notice.

No rights can be derived from the contents of this document.

Color guides: Color differences may occur due to different printing and publication methods.

ASSA ABLOY, Besam, Crawford, Albany and Megadoor, as words and logos, are examples of trademarks owned by ASSA ABLOY Entrance Systems or companies within the ASSA ABLOY Group.

Copyright © ASSA ABLOY Entrance Systems AB 2006-2016.

No part of this publication may be copied or published by means of scanning, printing, photocopying, microfilm or any other process whatsoever without prior permission in writing by ASSA ABLOY Entrance Systems.

All rights reserved.

Technical Overview

Features

Max size: (W x H)	5000 x 5000 mm
Panel thickness:	42 mm
Panel material:	Diamond grid
Filling:	CFC-free polyurethane, flame retardant DIN 4102-B2
Weight	13 kg/m ²
Color outside:	11 standard RAL colours
Color inside:	RAL 9002
Track types:	Standard: SL Optional: HL, VL
Windows:	Optional: DARP, DOAP, Framed section
Passdoor:	Not possible in the OH1042S
Electrical operation:	Optional: Automated operation, Access control, Safety functions

Performance

Opening/closing speed:	Opening 1,0 m/s, Closing 0,7 m/s
Life time expectations:	Door: 100.000 door cycles Springs: 20.000 door cycles, optional max.100.000 depending door configuration
Resistance to wind load, EN12424	Class 3 (≤ 4250 mm DLW) (Higher classes on request)
Thermal transmittance, EN12428	1,0 W/m ² K full panel (Door size 5000 x 5000 mm) Thermal calculations on exact door sizes and configurations are available on request
Resistance to Water penetration, EN12425	Class 3
Air permeability, EN12426	Class 3
Acoustic insulation, EN ISO 10140-2	R - 25 dB

Contents

Copyright and Disclaimer Notice	2
Technical Overview	3
Contents	4
1. Description	6
1.1 General	6
1.2 Dimensions	6
1.2.1 Daylight width and daylight height	6
1.2.2 Section sizes	6
1.3 Door leaf	6
1.3.1 Construction	6
1.3.2 Material	7
1.3.3 Vertical cross-section	7
1.3.4 Colors	8
1.3.5 Seals	8
1.3.6 Wind reinforcement truss	9
1.3.7 Handle	9
1.3.8 Lock bolt	9
1.4 Balancing system	10
1.4.1 Safety devices	10
1.5 CEN Performance	11
1.5.1 Lifetime expectation	11
1.5.2 Resistance to windload	11
1.5.3 Resistance to water penetration	11
1.5.4 Air permeability	12
1.5.5 Thermal transmittance	12
1.5.6 Acoustic insulation	12
1.5.7 Operating forces and safe openings	12
1.6 Track sets	13
1.6.1 General	13
1.6.2 SL - Standard Lift	13
1.6.3 HL - High Lift	13
1.6.4 VL - Vertical Lift	13
2. Available Options	14
2.1 Fixed sections	14
2.1.1 Fixed sections options	14
2.2 Windows	15
2.2.1 DARP	15
2.2.2 DAOP	15
2.2.3 Frame section	15
2.2.4 Number of windows	15
2.2.5 Windows	15
2.3 Optional colors *	16
2.4 Cylinder lock	16

3.	Operating system	17
3.1	Type of operation	17
3.2	Electrical operation.....	17
3.3	Speed Operator.....	17
3.4	Speed Door control system.....	18
3.5	Speed Door guidelines for automation.....	18
3.6	Access and automation.....	18
3.6.1	Basic control functions.....	18
3.6.2	External control functions.....	18
3.6.3	Automatic control functions.....	19
3.6.4	Safety functions.....	19
3.6.5	Additional functions.....	19
4.	Building and space requirements	20
4.1	Building preparations	20
4.1.1	Installation preparations.....	20
4.2	Space requirements	20
4.2.1	Space requirements SL.....	21
4.2.2	Space requirements HL.....	22
4.2.3	Space requirements VL.....	23
4.2.4	Space requirements Door operators.....	24
5.	Service	25
	Index	26

1. Description

1.1 General

The ASSA ABLOY OH1042S overhead sectional speed door, with its modern, clean design, is one of the fastest and well-insulated overhead doors on the market.

With an opening speed of one meter per second, the ASSA ABLOY OH1042S is designed for businesses with frequently used doors, vehicles of different height, better temperature control, regular door-collisions or an interest in reducing noise and dust.

The ASSA ABLOY OH1042S overhead sectional speed door has been designed to meet all operational and safety requirements in the European Directives and the standards issued by the European Standardization Committee, CEN.



The door has 4 primary parts:

- 1) Door leaf
- 2) Track set
- 3) Balancing system
- 4) Modern operating system

1.2 Dimensions

1.2.1 Daylight width and daylight height The standard ASSA ABLOY OH1042S overhead sectional door is delivered in the following size range:

	Daylight width	Daylight height
Min.:	2000 mm	2750 mm
Max.:	5000 mm	5000 mm

1.2.2 Section sizes

Section height:	545 mm
Top section height:	275 - 820 mm trimcut
Thickness:	42 mm

The door leaf height is achieved by trimcutting the top section.

1.3 Door leaf

1.3.1 Construction

The ASSA ABLOY OH1042S overhead sectional door leaf has horizontal sections, connected together with hinges. The outer hinges of each section have rollers that run in the tracks. The horizontal sections are insulated panels designed without thermal bridges for optimal insulation. The panels are filled with water blown CFC-free polyurethane.

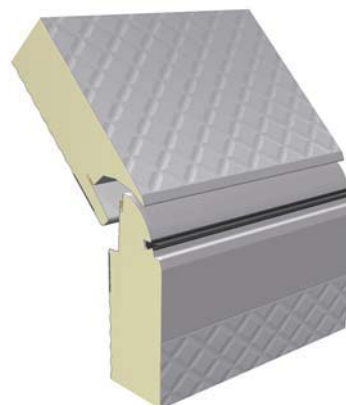

1.3.2 Material

The surface of the door leaf panels is a characteristic diamond grid steel sheet. The pre-coated steel door leaf panels fulfill outdoor corrosion resistance category RC3 according to EN 10169.

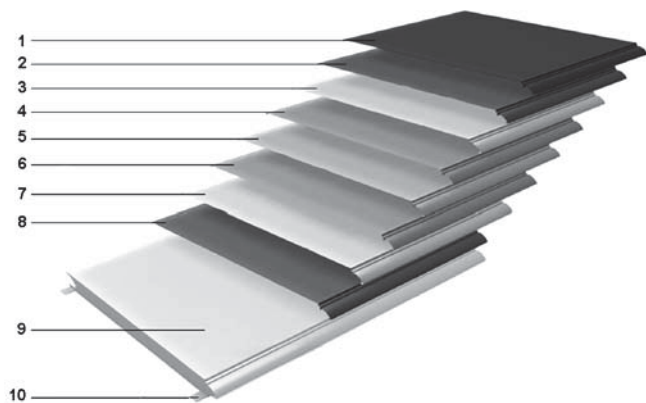

- 1) Polyester coating
- 2) Primer
- 3) Chromate layer
- 4) Zinc based metallic coating
- 5) Steel sheet
- 6) Zinc based metallic coating*
- 7) Chromate layer
- 8) Primer
- 9) CFC-free polyurethane (water blown), Flame retardant DIN4102-B2
- 10) Reinforcement strips

1.3.3 Vertical cross-section

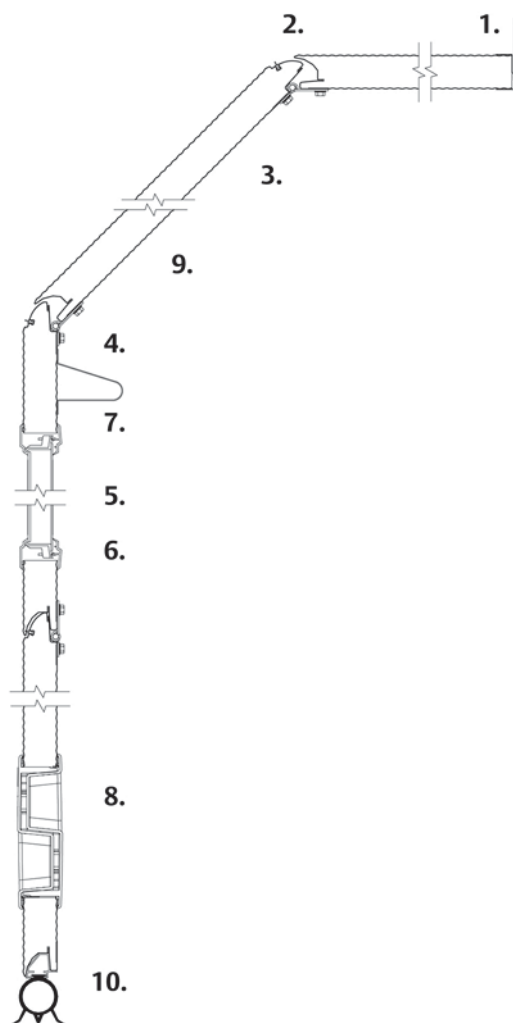

- 1) Top seal
- 2) Section joint with finger pinch protection and seals
- 3) Inner and outer sheet
- 4) Internal steel reinforcement, to provide positive fixing points
- 5) Window (optional)
- 6) High impact polystyrene frame
- 7) Panel truss - wind reinforcement (if necessary)
- 8) Step/lift handle
- 9) Insulation (CFC-free / water blown)
- 10) Bottom seal

1.3.4 Colors

The RAL-colors are as close as possible to the official RAL HR collection. Max. deviation is 1,0 ΔE (RAL 7016 excluded).

Pre-coated range:



RAL 1021



RAL 3002



RAL 5010



RAL 6005



RAL 7016



RAL 8017



RAL 9002

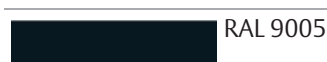

RAL 9005



RAL 9006



RAL 9007



RAL 9010

1.3.4.1 Pre-coated colors

- Outside color: The steel panel is available in the 11 standard RAL colours
- Inside color: RAL 9002 - Grey white.

1.3.5 Seals

The door is equipped with well designed seals on all sides that gives the door its excellent sealing abilities.

1.3.5.1 Top seal

Installed on the top panel to seal the gap between the panel and the wall. The double lip EPDM rubber top seal is mounted in an ABS adapter profile for optimal insulation and tightness.

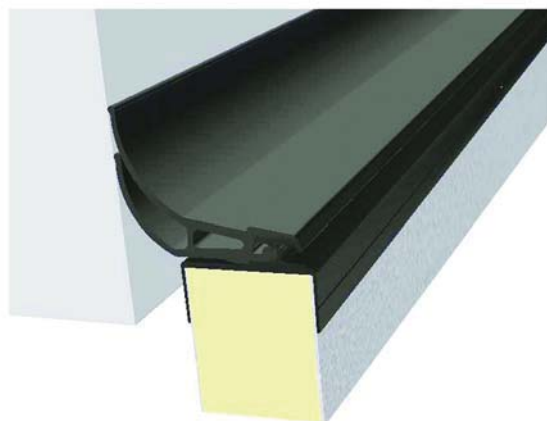

1.3.5.2 Side seal

Installed on the track set to close the gap between the tracks and the door leaf. The flexible rubber material provides continuous pressure on the door leaf, while dodging irregularities, ensuring maximum sealing.

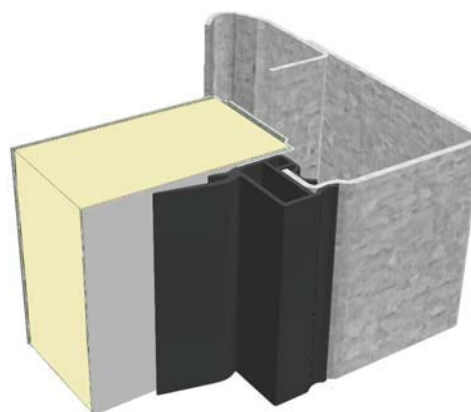

1.3.5.3 Bottom seal

Installed on the bottom edge of the bottom panel, to act as a barrier as well as a shock absorber. The flexible EPDM rubber material and the O-shape provides continuous pressure on the floor, ensuring maximum sealing. The bottom seal is mounted in an ABS adapter for optimal insulation and reduced risk of condensation.

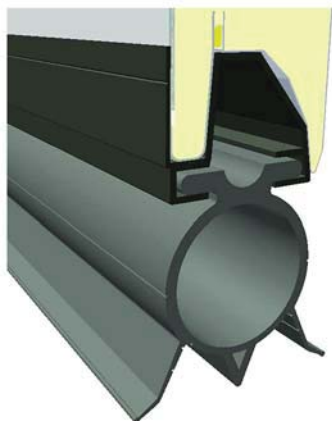

1.3.6 Wind reinforcement truss

Wider door panels and panels with windows are reinforced with metal profiles that act as trusses. These trusses reduce bending of the panel caused by wind loads or when the door leaf is in the horizontal position and is bending under its own weight. The truss is sloped to prevent objects being placed on it which could fall when the door opens. Nice plastic endcaps prevent dust is collected in the truss.

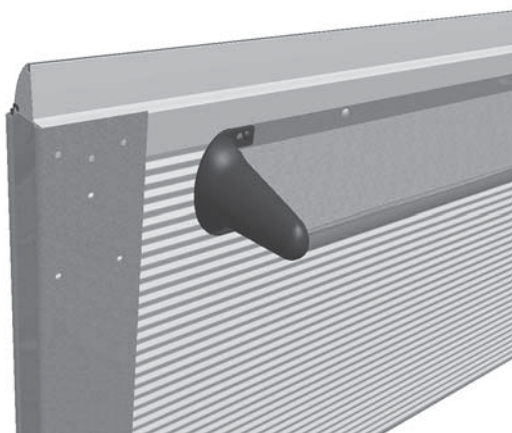

1.3.7 Handle

For manual operation, every ASSA ABLOY OH1042S overhead sectional door is provided with a solid, easy to grip and step-on handle, finished with the ASSA ABLOY logo.



1.3.8 Lock bolt

A standard ASSA ABLOY OH1042S overhead sectional door is equipped with a Lock bolt.

The Lock bolt locks the door from the inside, without the use of a key. The Lock bolt is not visible from the outside.



1.4 Balancing system

The balancing system balances the door by applying a force nearly equal to the weight of the door leaf. This allows the door leaf to be moved up and down manually, and to stay open in any position.

The system is installed on the top or the end of the track set and works as follows: Two torsion springs are installed on a shaft above the door opening. This shaft has a cable drum on each end from which door cables run to the bottom corners of the door leaf. Turning the shaft moves the door up or down.

1.4.1 Safety devices

The balancing system supports heavy forces. In case of a spring or cable break, its counterforce is lost. The door is therefore equipped with two safety devices that can block downward door movement:

- Spring Break Device (standard)
- Slack Rope Switch (standard)

1.4.1.1 Spring break device (SBD)

The Spring Break Device (SBD) is delivered with all ASSA ABLOY OH1042S overhead sectional doors.

In the event of a spring break, the sudden drop force activates the Spring Break Device (SBD). The shaft will be locked in less than 300mm of door movement.



1.5 CEN Performance

1.5.1 Lifetime expectation

- 100.000 door cycles or 10 years (in a normal industrial environment)
- Springs: 20.000 door cycles, optional max.100.000 depending door configuration

1.5.2 Resistance to windload

EN12424

Test result	Class 3
-------------	---------

Class	Pressure Pa (N/m ²)	Specification
0	-	No performance determined
1	300	
2	450	
3	700	
4	1000	
5	> 1000	Exceptional : Agreement between manufacturer and supplier

1.5.3 Resistance to water penetration

EN12425

Test result	Class 3
-------------	---------

Class	Pressure Pa (N/m ²)	Specification
0	-	No performance determined
1	30	Waterspray for 15 minutes
2	50	Waterspray for 20 minutes
3	> 50	Exceptional : Agreement between manufacturer and supplier

1.5.4 Air permeability

EN12426

Test result Class 3

Class	Air permeability dp at a pressure of 50 Pa (m ³ /m ² /h)
0	-
1	24
2	12
3	6
4	3
5	1,5
6	Exceptional : Agreement between manufacturer and supplier

1.5.5 Thermal transmittance

EN12428

Thermal transmittance 1,0 W/m²K full panel

(Door size 5000mm x 5000mm)

1.5.6 Acoustic insulation

ISO 10140-2

Acoustic insulation * R - 25 dB

*Door surface 4.000 x 2.500 mm (for other sizes it can differ)

1.5.7 Operating forces and safe openings

EN12453 & EN12604	Crushing force N	Crushing force N	Crushing force N
Opening gap mm	200 mm from lateral border right from outside	In the middle of the door opening	200 mm from lateral border left from outside
50 mm	passed	passed	passed
300 mm	passed	passed	passed

The crushing force is the force needed for the safety edge to be activated. The maximum force allowed, according to EN12453 safety in use of power operated doors is 400 N within a maximum period of time of 0.75s.

With standard light curtain there is no crushing force.

1.6 Track sets

1.6.1 General

The track set supports the door leaf on its rollers and guides it upwards. The selection of the appropriate track set is based on various factors:

- Available head room
- Door height
- Type of vehicles
- Presence of roof obstructions, pipes and overhead crane beams.

The track sets below cover most applications. Other applications are available on request.

1.6.2 SL - Standard Lift

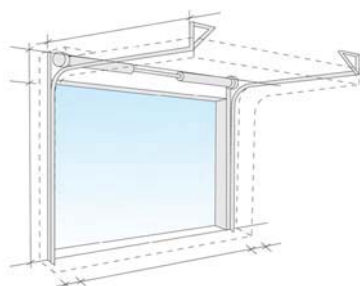

- Building type: Most standard industrial buildings.
- Benefits: Optimal design for common buildings.

The Standard Lift track set, with the spring package just above the door, is the most common solution

1.6.3 HL - High Lift

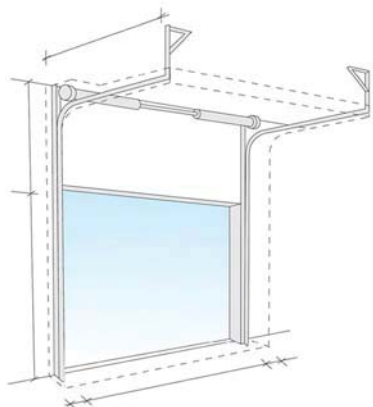

- Building type: High ceilings. On the High Lift track set the spring package is placed high above the door.
- Benefits: This track type allows high vehicles to cross along the door opening without obstructions of the horizontal tracks.

This track type is used when the space above the door is considerable, and is needed for work and traffic, e.g.: high vehicles.

1.6.4 VL - Vertical Lift

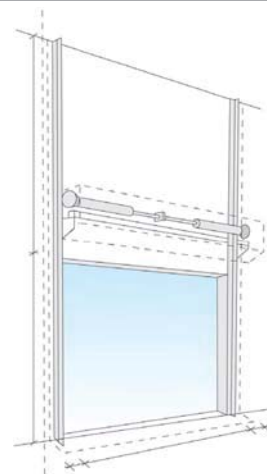

- Building type: Very high ceiling and high working space requirements.
- Benefits: Allows high vehicles to cross along the door opening without any obstructions.

If the space between the daylight height and the roof is sufficient, with this track type, the door can be opened vertically.

2. Available Options

2.1 Fixed sections

Fixed sections can advantageously fill space around new doors that are smaller than the wall opening. Fixed sections are available in top and side sections, with or without windows or passdoor. Fixed sections are supplied in the same color and construction as the door leaf.

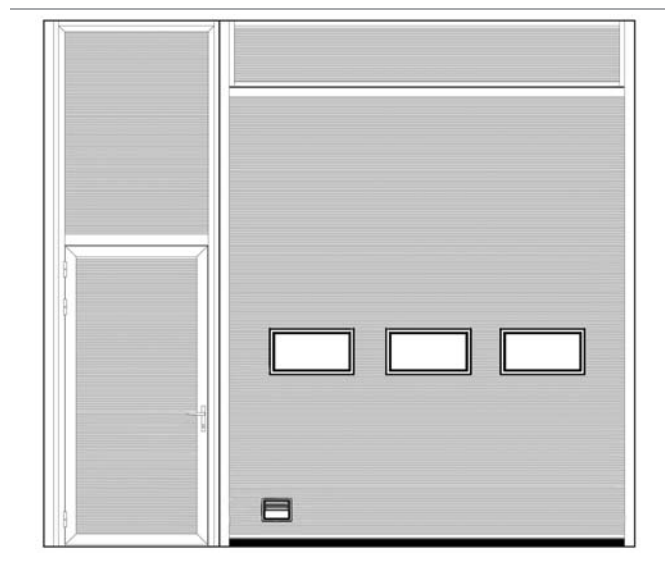

Maximum size in mm (Daylight width - Daylight height)

Passdoor	1495 - 2440
Side panel with passdoor (A)	1495 - 6000
Side panel with passdoor (B)	2400 - 2076
Side panel with passdoor (C)	2400 - 6000
Side panel without passdoor	2400 - 6000
Side panel without passdoor (loose sections)	8000 - 6000
Top panel (loose sections)	8000 - 6000

2.1.1 Fixed sections options

Minimum size in mm (Daylight width - Daylight height)

Passdoor	800 - 2076
Side panel with passdoor (A)	800 - 2441
Side panel with passdoor (B)	1496 - 2076
Side panel with passdoor (C)	1496 - 2441
Side panel without passdoor	300 - 300
Side panel without passdoor (loose sections)	83 - 140
Top panel (loose sections)	83 - 83

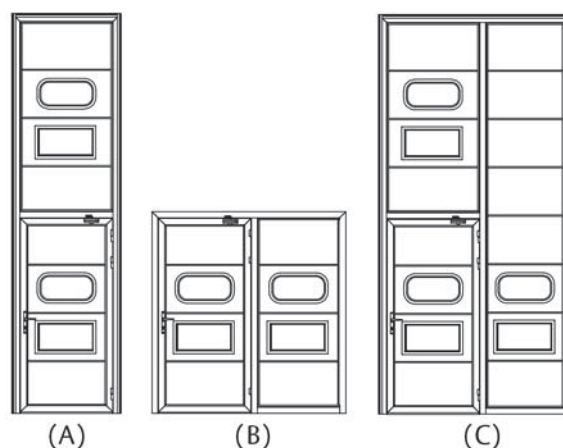

2.2 Windows

The door sections can be glazed with windows*. The number of windows per section is directly related to the daylight width. Optionally, one single window can be placed on the outer left or right side, in the third section.

*The bottom section cannot be glazed.

2.2.1 DARP



- Double Acrylic (3 + 2 mm) Rectangular, in Plastic frame
- Light opening: 604 x 292 mm
- Window frame: Black

2.2.2 DAOP



- DAOP: Double Acrylic (3 + 2 mm) Oval, in Plastic frame
- Light opening: 610 x 292 mm
- Window frame: Black

2.2.3 Frame section

The ASSA ABLOY OH1042S overhead sectional door can be fitted with 1 or 2 ASSA ABLOY OH1042F frame sections. The height of this section is 545mm. Please refer to ASSA ABLOY OH1042F documentation for details.



2.2.4 Number of windows

For windows the daylight width is divided into a fixed grid. The number of windows depends on the daylight width of the door.

Windows

No. of windows	Daylight width
1	2050 - 2134 mm
2	2135 - 2999 mm
3	3000 - 3864 mm
4	3865 - 4729 mm
5	4730 - 5000 mm

Optional: One window in the outer left or right side of section 3 only.

2.2.5 Windows

DARP

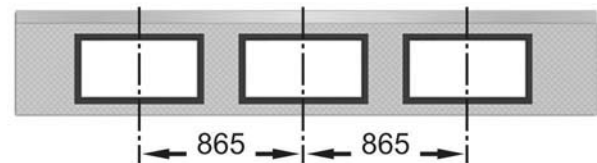

DAOP

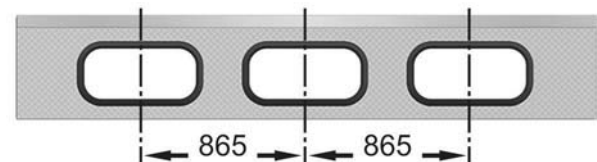

2.3 Optional colors *

Factory painting

The door leaf can be factory painted in any RAL and NCS colour plus some metallic colours, outside only. The painting can be applied to only the panel or to the complete door leaf, including frames and strips.

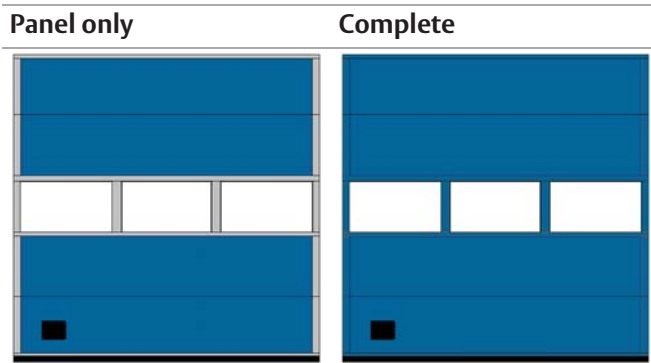

* Other colors available on request

2.4 Cylinder lock

The Cylinder lock is a key operated lock which offers extra security. The lock is installed on the inside and can be unlocked with a key and turning the handle. Access to the Cylinder lock is possible from either only the inside, or both the inside and the outside.



3. Operating system

3.1 Type of operation

An ASSA ABLOY OH1042S overhead sectional door is always electrically operated. If needed the door can be opened and closed manually. Electrically operated doors can be controlled by hand or be fully automatic.

3.2 Electrical operation

The ASSA ABLOY OH1042S overhead sectional door will be supplied with a high performance electrical operating system. This operating system gives access to the full program of Access and Automation functions, that can fulfill many operational needs, related to traffic type and frequency, door weight and temperature control.

3.3 TS 971XL Door control

The TS 971XL Door control system is an advanced control unit that is prepared for upgrades from the range of automation systems. An automation system allows door operation by sensors or remote control.

The TS 971XL control unit contains a diagnostics display that allows efficient troubleshooting and displays the number of door cycles. This extra feature allows advanced maintenance planning to users where the door is an essential element of internal logistics.



- Dimensions: 300 x 400 x 165 mm (wxhxd)
- Standard actuator UP-STOP-DOWN and pulse control
- Self monitoring light grid.
- Automatic closing after set period 0-240s.

3.4 SR-SI 8.180 FU-35,00 Operator

A main part of the system is the SR-SI 8.180 FU-35,00 speed operator: an electric motor which drives the balancing shaft with the cable drums and torsion springs. The speed operator is mounted directly on the balancing shaft and does not require any special wall reinforcement.

Key features:

- Smooth and silent
- Soft start and soft stop
- Shaft: $\varnothing 35$ mm tube or solid



	SR-SI 8.180 FU-35,00 Operator
Voltage supply: +/- 10%	230V AC 1-phase 50/60Hz
Power:	0,85 kW
Degree of protection:	IP65, with CEE plug, IP 54
Allowed door weight, max.:	300 kg
Temperature working range:	+5 °C to +40 °C*
Operating factor:	ED = 30% S3 10 min. intermittent

3.5 Speed Door guidelines for automation

The “Automation F-kits” are packages of common combinations. These kits can also be supplemented by “additions to F-kits”.

Automation F-kits	F1	F2	F4
Magnetic loop		<input type="checkbox"/>	<input type="checkbox"/>
Warning lights - Red	<input type="checkbox"/>		<input type="checkbox"/>
Additions to F-kits			
Warning lights - Green	<input type="checkbox"/>	<input type="checkbox"/>	<input type="checkbox"/>
Relay box			
Radar	<input type="checkbox"/>	<input type="checkbox"/>	<input type="checkbox"/>

■ Standard

□ Option / Available

3.6 Access and automation

ASSA ABLOY offers a wide range of functions that allows advanced opening and safety control. Please refer to the specification sheet of the control units to see which functions apply to which models.

3.6.1 Basic control functions

3.6.1.1 Reduced opening

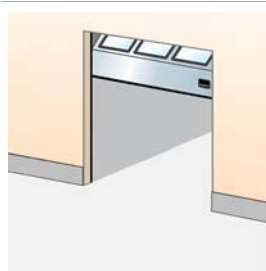

When it is unnecessary or undesirable to fully open a door, an additional switch can be used to open the door to a pre-programmed reduced opening position.

3.6.2 External control functions

3.6.2.1 External push button box

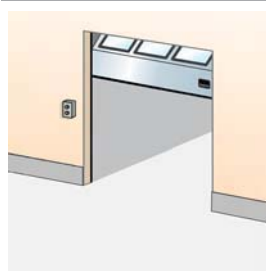

An extra control box is installed outside the building or inside close to the door if the main control unit needs to be installed away from the door opening. Installed on the inside or outside wall beside the door.

3.6.2.2 Pull-rope switch

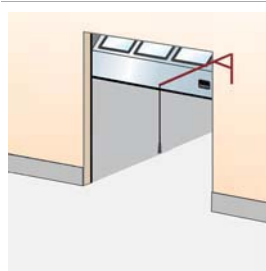

A pull-rope switch above the door opening can be operated from e.g. a forklift truck. Pulling the rope opens a closed door or closes an opened door. Installed on the inside construction above the door.

3.6.2.3 Remote control

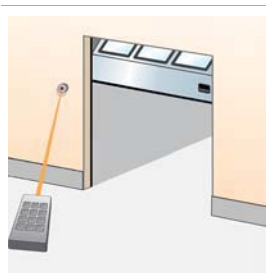

A hand-held radio transmitter allows door operation from a vehicle or any position within 50-100 meters from the receiver and aerial at the door. For closing, the door can be provided with a photocell beam. Receiver installed in control unit, antenna installed on the wall beside the door.

3.6.3 Automatic control functions

3.6.3.1 Magnetic loop



A sensor in the floor detects a metal object (usually forklift trucks, pallet trucks) and opens the door automatically. This is an ideal solution for frequent vehicle traffic.
Installed on the outside, inside or both sides of the door in the floor.

3.6.3.2 Radar

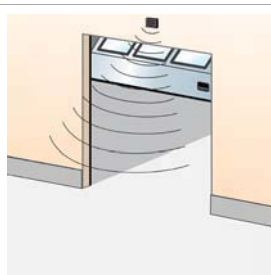

An infrared sensor above the door detects an object (person, vehicle) within a specified distance from the door and opens the door automatically. This is an ideal solution for frequent vehicle or personal traffic. Often combined with automatic closing.
Installed on the inside or outside wall above the door.

3.6.3.3 Photocell open door

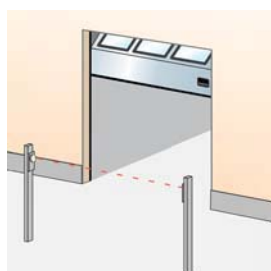

A set of photocells on pillars, on each side of the door. When a person or vehicle passes between the photocells, the beam is interrupted and the door opens. Photocells installed on pillars, away from the door.

3.6.3.4 Automatic closing

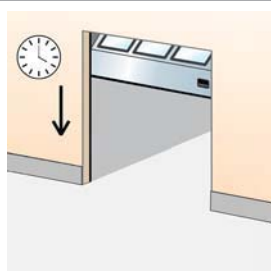

A programmable timer that closes the door after a specified time, counted from either the fully open position and/or from passing through the photocell beam. Adjustable micro switches in control unit.

3.6.4 Safety functions

3.6.4.1 Light curtain

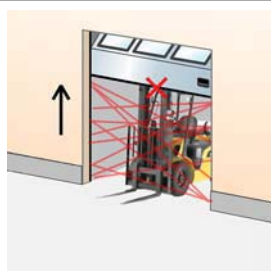

The speed door is standard equipped with a light curtain. These strips of photocells in the tracks detect any obstruction under a closing door and reverse the door.

3.6.4.2 Warning lights - Red

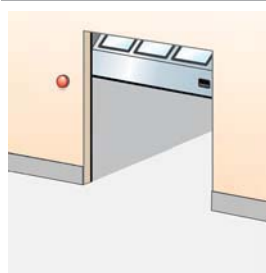

Two red warning lights giving information on the current door behaviour. Flashing light before or during door movement. Optional: Continuous light before and during door movement.
Installed on the inside and outside wall beside the door.

3.6.4.3 Warning lights - Green

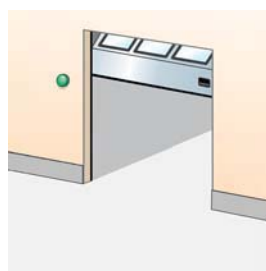

One or two green warning lights indicating the open position of the door by continuous light signal.
Installed on the inside and/or outside wall beside the door.

3.6.4.4 Traffic lights - Red & Green

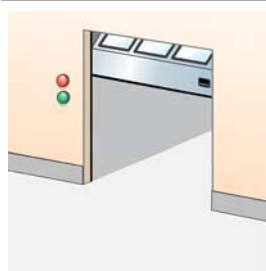

If traffic through a door needs to be directed; two red and two green traffic lights can be installed to indicate traffic direction. From the side where a vehicle is first detected to approach the door, the green traffic light comes on. The opposing side shows a red traffic light. Traffic from this direction must give way to the other. Usually installed in e.g. parking garages.
Installed on the inside and outside wall beside the door.

3.6.5 Additional functions

3.6.5.1 UPS battery backup



When mains failure cannot be permitted or an increased risk of mains failure is predicted, the UPS battery backup system can be installed to store enough energy for 5 door cycles.
Installed on the inside wall beside the door.

4. Building and space requirements

4.1 Building preparations

4.1.1 Installation preparations

The ASSA ABLOY OH1042S overhead sectional door is shipped in parts and installed on-site. All necessary installation material is included. For every track type ASSA ABLOY offers specific installation kits to position the door in the building facade.

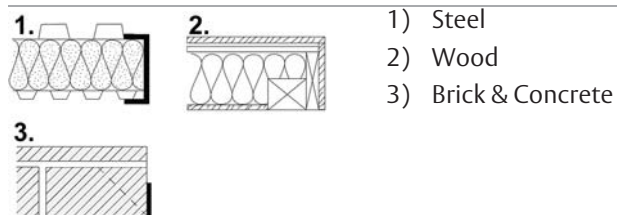

4.2 Space requirements

DLH	= Daylight Height	The height of the clear opening
DLW	= Daylight Width	The width of the clear opening
D	= Depth	The space between the inner side of the wall and the end of the horizontal track construction
h	= Excess height	The extra space required above the daylight height.
SL	= Side space Left	The space required for tracks beside the daylight width.
SR	= Side space Right	The space required for tracks beside the daylight width.

The grey marked area in the illustrations shows the free space required by door movement. Extra space requirements for electrically operated doors are stated in the operator specifications.

4.2.1 Space requirements SL

DLW	≤ 5000 mm
DLH	≤ 5000 mm
h	485 mm (if DLH \leq 4500 mm) 510 mm (if DLH $>$ 4500 mm)
SL/SR	130 mm, 320 mm on operator side
D	DLH + 600 mm

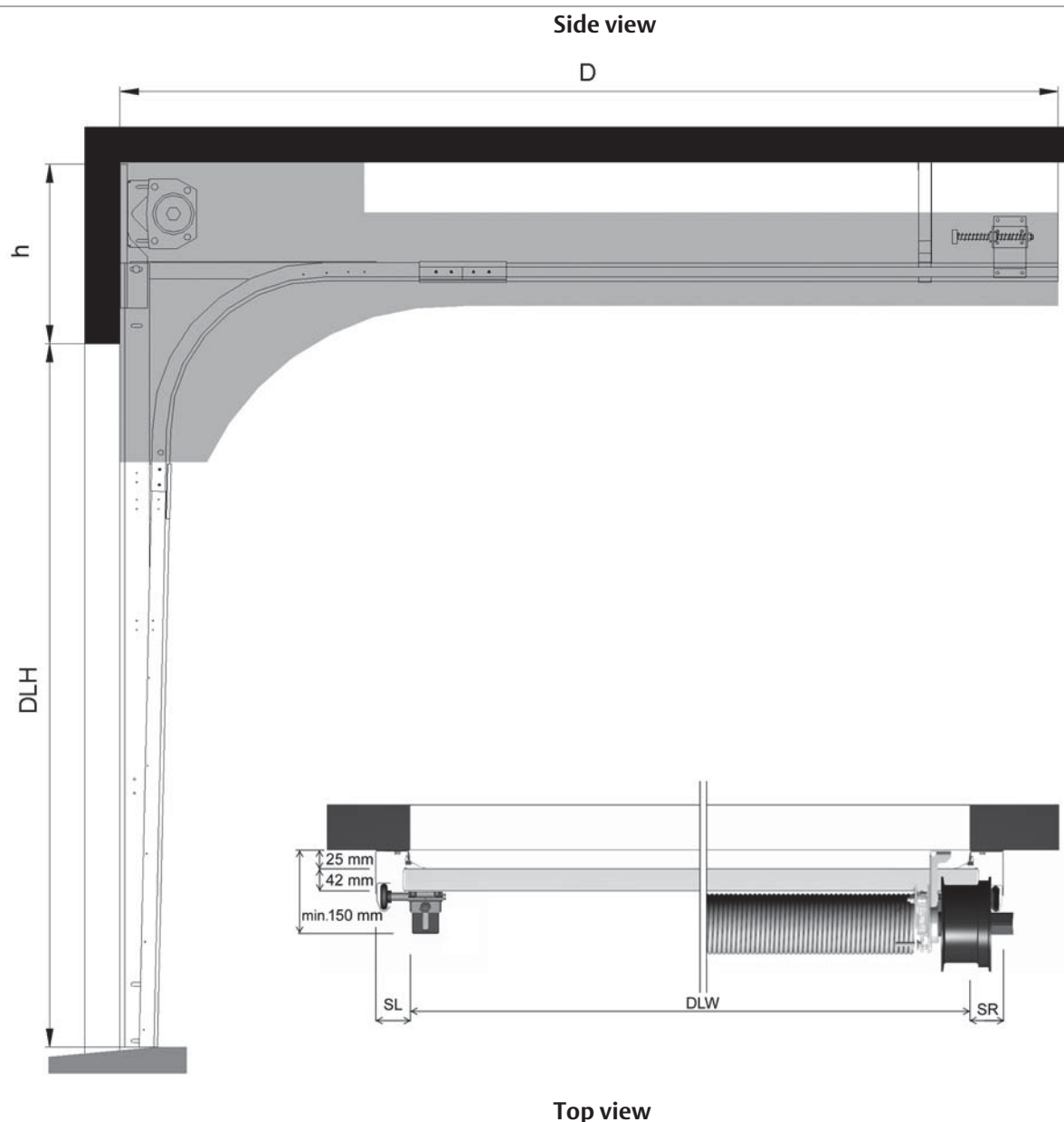

4.2.2 Space requirements HL

DLW	≤ 5000 mm
DLH	≤ 5000 mm
h	HL+320 mm (if HL ≤ 3400 mm) HL+370 mm (if HL > 3400 mm)
SL/SR	130 mm, 320 mm on operator side
D	DLH - HL + 800 mm

The following doors must be installed on a frame, equipped with an A-65 top seal.

- Doors DLW > 4000 mm with a dark outside colour, installed facing south.

Side view

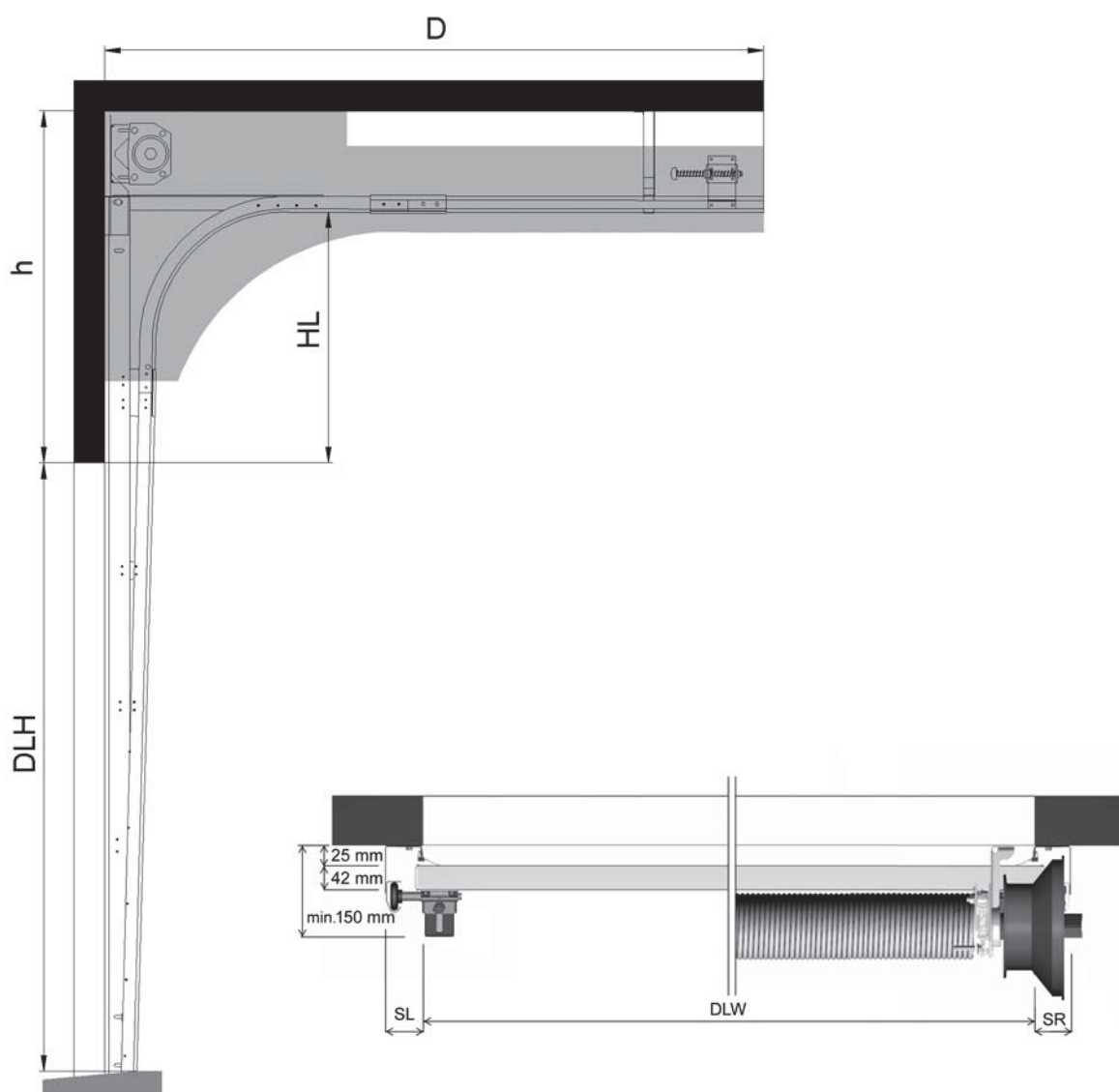

Top view

4.2.3 Space requirements VL

DLW	≤ 5000 mm
DLH	≤ 5000 mm
h	DLH + 525 mm
SL/SR	130 mm, 320 mm on operator side
D	VLS = 525 mm

The following doors must be installed on a frame, equipped with an A-65 top seal.

- Doors DLW > 4000 mm with a dark outside colour, installed facing south.

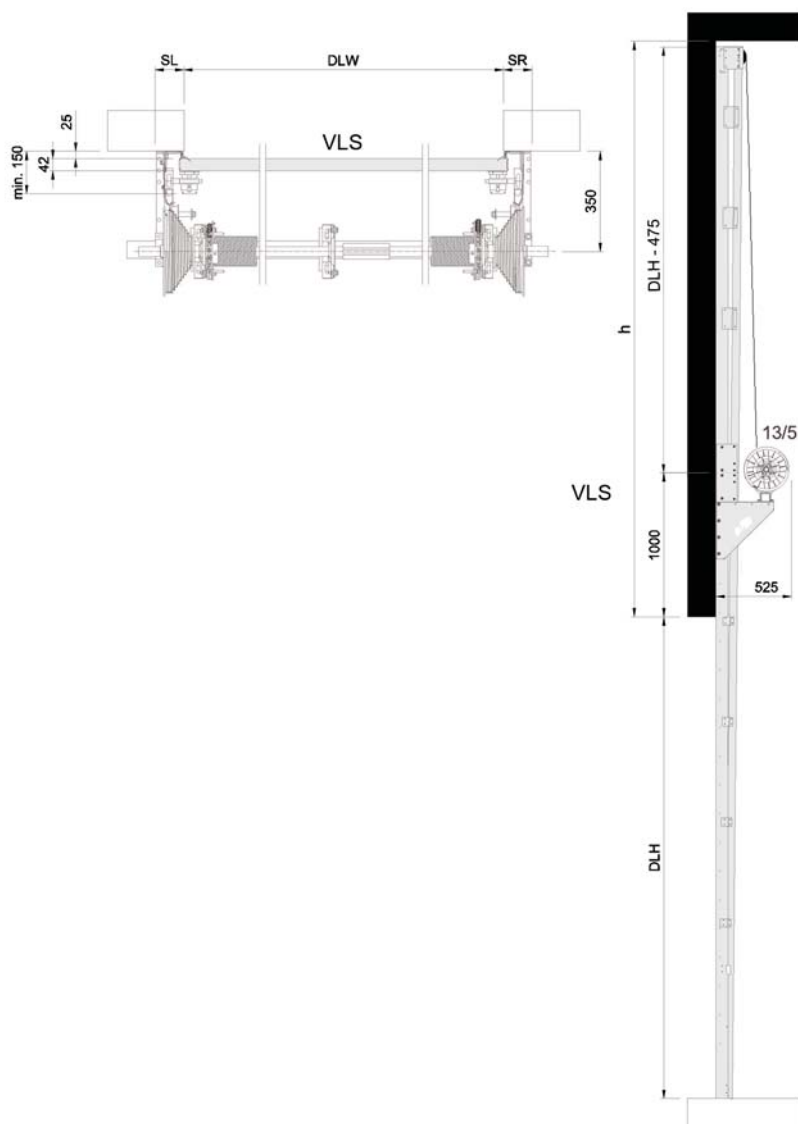

4.2.4 Space requirements Door operators

4.2.4.1 OH1042S Installation locations

Location of OH1042S operator

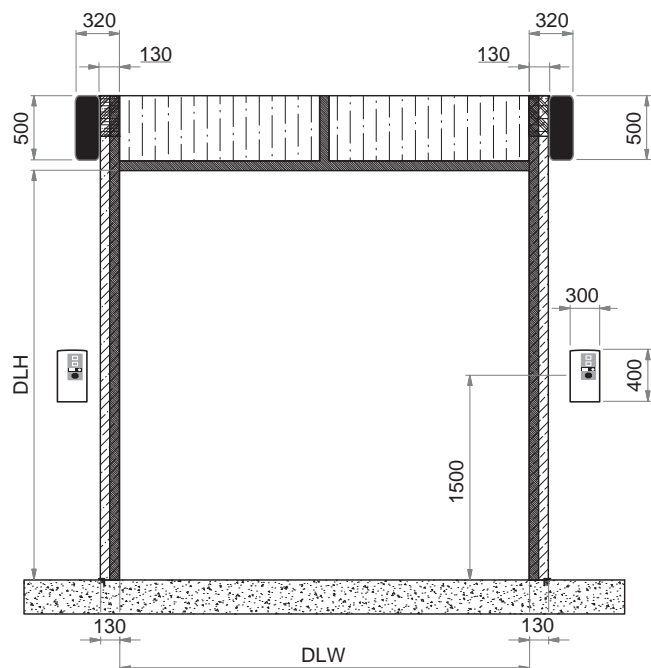

5. Service

Preventive Maintenance Program and Modernization Services

As your entrances are part of your business flow, there's every reason to keep them working well. ASSA ABLOY Entrance Systems offers you a maintenance and modernization expertise to rely on. Our Maintenance Programs and Modernization Services are backed by a extensive expertise for all types of industrial door and docking systems, independent of brand. At your disposal is a team of dedicated expert technicians, proven through decades of maintenance, service and satisfied customers.

Preventive Maintenance Programs

Minimizing lost time, lost energy and unexpected hassle is our team's constant objective. Our service organization can support you 24/7 in maintaining all industrial door and docking systems, independent of brand. If you want to be one step ahead of break-downs, explore our portfolio of Pro-Active Care plans. Naturally, we also offer entrance upgrades to suit your specific wishes and business needs.

Pro-Active Care - Maintenance plans to fit your business

Regular maintenance can extend the lifetime of your equipment and help prevent unexpected problems. Our technician arrives on-site equipped with the knowledge and tools to service all automatic entrances, independent of brand.

- **Pro-Active Bronze**

The base on which all Pro-Active Plans are built provides the security of knowing that your equipment is regularly inspected and certified for safety, as well as performing optimally. It includes a number of planned on-site visits depending on your needs. Any unplanned service calls required during the term of the contract (including labor, travel and parts) are billed at special Pro-Active Care prices.

- **Pro-Active Silver**

This plan provides all the benefits of Pro-Active Bronze with the added advantage of labor and travel being included for service calls during regular business hours. The only additional charge would be for any parts that may be needed throughout the term of the contract.

- **Pro-Active Gold**

This plan provides the ultimate protection for your automatic entrance investment. It includes all the benefits of Pro-Active Silver, plus replacement of any parts required during an unplanned repair or planned maintenance visit. Pro-Active Gold is an excellent way to budget your automatic door expenses annually.

- **Pro-Active Tailor-Flex**

Our most flexible maintenance and service offering. The Pro-Active Care plan is designed by you, our customer. The plan allows you to balance your maintenance expenses against your real-world budget and presents the option to add or delete a number of maintenance elements to suit your budget goals, while meeting your overall performance and safety needs.

Modernization

Your entrances are a long-term investment, from which you always want the best. Products develop over time, so do regulations and your business. Let us help you increase energy savings and meet today's standards. We provide advice and modernization kits for outdated installations, ensuring your investment meet requirements and performs optimally for many more years to come.

Re-Active Service		Pro-Active Care				
		Pro-Active Bronze	Pro-Active Silver	Pro-Active Gold	Pro-Active Tailor Flex	
		○	○	○	●	Other customized requests such as Response Time, Performance InfoPack and Advanced User Training
		○	○	●	○	Replacement of worn parts according to preventive Consumable Exchange Program
		○	○	●	○	Replacement of spare parts on breakdowns
		○	●	●	○	Travel and labor for additional call-out visits
		●	●	●	●	Preventive maintenance visits 1-4 times per year
		●	●	●	●	Travel and labor for preventive maintenance visits
		●	●	●	●	Response time and priority on call-outs <24h
		●	●	●	●	Preventive planned maintenance that meets the most demanding standards in the market
	●	●	●	●	●	Safety and quality checks according to applicable regulations and norms. Documentation of test results provided
●	●	●	●	●	●	Documentation of equipment status, assessment and service provided, all generated on site
●	●	●	●	●	●	Highly trained professional technicians with extensive knowledge, state-of-the-art tools and the right spare parts*
●	●	●	●	●	●	Dedicated Professional Customer Care Hotline
Corrective	SafetyCheck	Pro-Active Bronze	Pro-Active Silver	Pro-Active Gold	Pro-Active Tailor Flex	

● = Included as standard
○ = Available at special prices
* Well-stocked service vehicles with genuine and new spare parts

Index

Numerics

1042S Installation locations 24

A

Access and automation 18

Acoustic insulation 12

Additional functions 19

Air permeability 12

Automatic closing 19

Automatic control functions 19

Available Options 14

B

Balancing system 10

Basic control functions 18

Bottom seal 9

Building and space requirements ... 20

Building preparations 20

C

CEN Performance 11

Colors 8

Construction 6

Copyright and Disclaimer Notice 2

Cylinder lock 16

D

DAOP 15

DARP 15

Daylight width and daylight height ... 6

Description 6

Dimensions 6

Door leaf 6

E

Electrical operation 17

External control functions 18

External push button box 18

F

Features 3

Fixed sections 14

Fixed sections options 14

Frame section 15

G

General 6, 13

H

Handle 9

HL - High Lift 13

I

Installation preparations 20

L

Lifetime expectation 11

Light curtain 19

Lock bolt 9

M

Magnetic loop 19

Material 7

N

Number of windows 15

O

Operating forces and safe openings 12

Operating system 17

Optional colors * 16

P

Performance 3

Photocell open door 19

Pre-coated colors 8

Pull-rope switch 18

R

Radar 19

Reduced opening 18

Remote control 18

Resistance to water penetration 11

Resistance to windload 11

S

Safety devices 10

Safety functions 19

Seals 8

Section sizes 6

Service 25

Side seal 8

SL - Standard Lift 13

Space requirements 20

Space requirements Door operators 24

Space requirements HL 22

Space requirements SL 21

Space requirements VL 23

Speed Door control system 18

Speed Door guidelines for automation
18

Speed Operator 17

Spring break device (SBD) 10

T

Technical Overview 3

Thermal transmittance 12

Top seal 8

Track sets 13

Traffic lights - Red & Green 19

Type of operation 17

U

UPS battery backup 19

V

Vertical cross-section 7

VL - Vertical Lift 13

W

Warning lights - Green 19

Warning lights - Red 19

Wind reinforcement truss 9

Windows 15

ASSA ABLOY Entrance Systems is a leading supplier of entrance automation solutions for efficient flow of goods and people. With our globally recognized product brands Besam, Crawford, Albany and Megadoor, we offer products and services dedicated to satisfying end-user needs for safe, secure, convenient and sustainable operations.
ASSA ABLOY Entrance Systems is a division within ASSA ABLOY.

assaabloyentrance.com



ASSA ABLOY Entrance Systems

assaabloyentrance.com