

# Dock leveler

ASSA ABLOY DL6010SA

ASSA ABLOY

ASSA ABLOY Entrance Systems

The global leader in  
door opening solutions

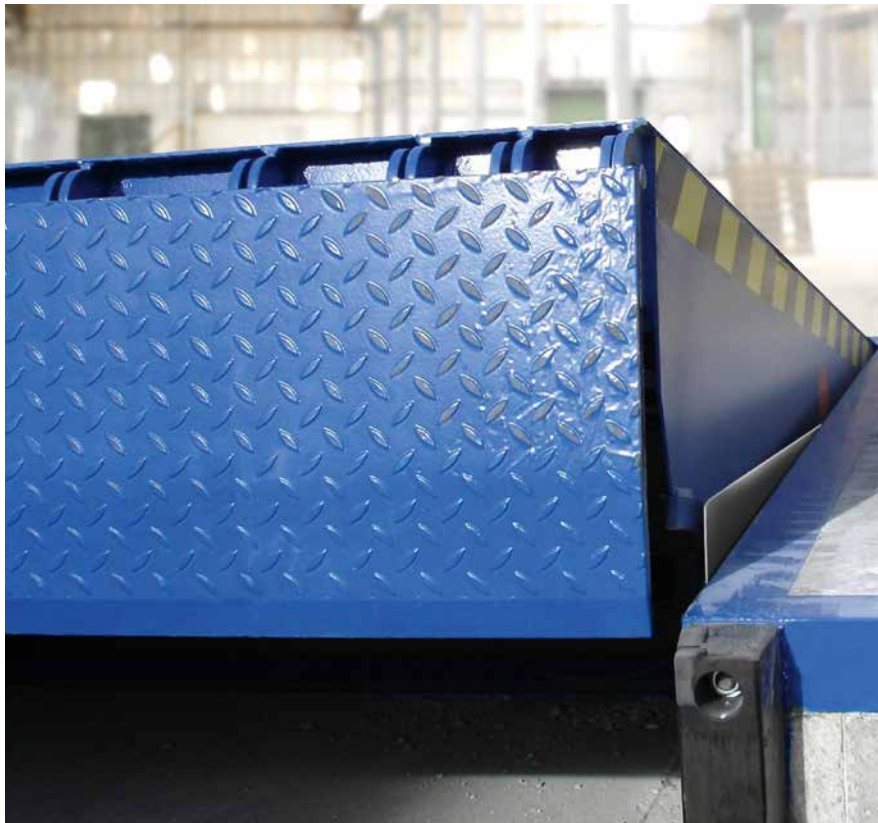

## Swing lip dock leveler with self supporting frame

The ASSA ABLOY DL6010SA Swingdock Autodock has a self supporting frame for easy integration with a building. It is the base of a complete Load house outside the building containing all relevant components, leveler, shelter and door to make it a total docking solution.

To enable a safe and efficient process for loading and unloading, the ASSA ABLOY DL6010SA Swingdock Autodock connects the building with the vehicle. The result is highest safety for the transfer of goods, avoiding injuries to the personal or damages to the equipment.

The ASSA ABLOY DL6010SA Swingdock Autodock:

- Preventive maintenance is easy and fast to secure functionality and avoid downtimes.
- Bent swing lip prevents material handling equipment from "grounding out".
- Swing lip with open hinges to avoid blockage of swinging out movement, free of cleaning, and very easy to maintain.
- Very robust Swing lip support with burned plates. All impact forces are absorbed in optimal way avoiding damages and providing long life time.

### ASSA ABLOY 950 series - the intelligent, all in one, docking control system

The innovative and unique 950 series docking control system gives you direct control of the dock leveler, dock shelter and door all in one control unit. With only a few self explaining buttons it is easy to operate, to meet the demands of modern logistics. Separate steering units or complex wiring are no longer needed.

### ASSA ABLOY DE6090DI Dock-IN

ASSA ABLOY Dock-IN is the world's first combined solution with parking guide and traffic lights in one system. ASSA ABLOY Dock-IN ensures a safe and secure dock in procedure with the help of white guiding lights and red traffic lights. There is no need to paint and repaint guiding lines on the asphalt or install conventional steel parking guides, which are an obstacle in the yard. With modern LED technology ASSA ABLOY Dock-IN has a low energy consumption and a long life.

## Technical Data

Nominal length <sup>1</sup>	2000, 2450, 3000 mm
Nominal width AD	3300, 3500, 3600, 3750 mm
Leveler width	2000, 2200 mm
Load capacity	60 kN (6 tonnes)
Vertical working range	
Rise above dock	up to 430 mm
Fall below dock	down to 360 mm
Platform tear-plate thickness	6/8 mm - 8/10 mm
Max. point load leveler platform	1,3 N / mm <sup>2</sup> (6 mm tear plate) 6,5 N / mm <sup>2</sup> (8 mm tear plate)
Lip material & length	steel, 400 / 500 mm
Control unit protection class	IP 54
Nominal voltage	400V 3-phase, 230V 3-phase
Nominal motor power	0,75 kW
European standard	EN 1398 Dock levelers
1) Other sizes on request	

## Dimensions

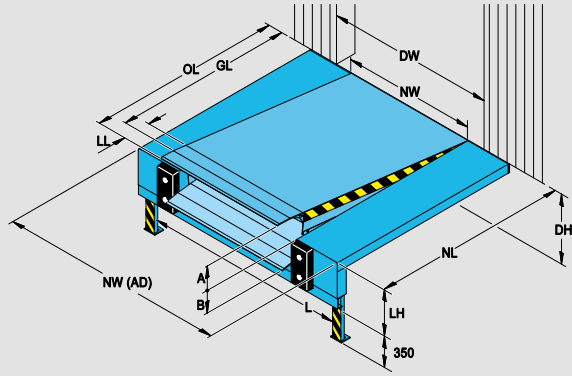

Dimensions				Vertical working range			
				LL 400		LL 500	
NL	OL	GL	LH	A	B	A	B
2000	NL+350	NL+210	700	290	330	180	360
2450	NL+335	NL+195	700	380	340	260	360
3000	NL+350	NL+210	700	400	335	280	290

Nominal width 2000, 2200  
Nominal width (AD) 3300, 3500, 3600, 3750

NL	Nominal length
OL	Overall length
GL	Gradient length
NW	Nominal width
LL	Leveler length
LH	Leveler height
A	Working range above dock level
B	Working range below dock level
DH	Dock height
DW	Door width
NW (AD)	Nominal width Autodock (incl. side tread panels)
L	Distance between plinths
OW (AD)	Overall width Autodock = NW (AD) - 20

## Electrical preparations

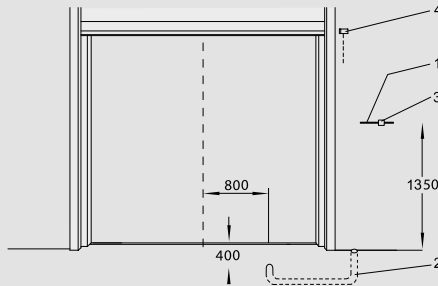

1	Mains supply:	3 / N / PE AC 50 Hz 230 / 400V
	Mains fuse:	D0 10 A gL
	Motor power:	0,75 kW
2	Conduit for wiring internal diameter	70, angles <45° (by others)
3	Mains isolator*:	Only for control box with emergency stop
4	Optional safety switch on sectional door	to disable leveler when door is closed*

\*Non standard

## Operating functions for swing lip levelers

950 L SD / 950 LA SD



950 DL SD / 950 DLA SD



950 LS SD / 950 LSA SD



950 DLS SD / 950 DLSA SD





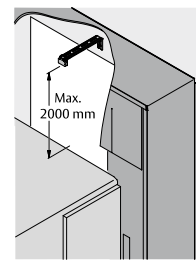
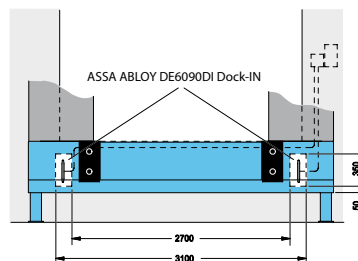
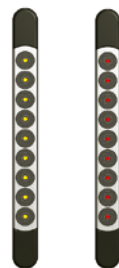

SD = Swingdock  
L = Leveler  
A = Auto Button  
D = Door  
S = Shelter

## ASSA ABLOY DE6090DI Dock-IN



## Standard available colours

	Red RAL 3002		Green RAL 6005		Hot dip galvanised
	Blue RAL 5010		Jet Black RAL 9005		