

Dock leveler

ASSA ABLOY DL6010SR

ASSA ABLOY

ASSA ABLOY Entrance Systems

The global leader in
door opening solutions



The dock leveler upgrade solution - for replacement of existing levelers

A ASSA ABLOY DL6010SR Swingdock Replacement is a cost-effective upgrade solution to replace obsolete dock levelers. The wide sizes range and the variety of frame designs make it possible to replace existing levelers without any reconstruction. Your expert from ASSA ABLOY will do the visual inspection and find the best solution for your individual situation.

The ASSA ABLOY DL6010SR Swingdock Replacement:

- Preventive maintenance is easy and fast to secure functionality and avoid downtimes.
- Bent swing lip prevents material handling equipment from "grounding out".
- Swing lip with open hinges to avoid blockage of swinging out movement, free of cleaning, and very easy to maintain.
- Very robust Swing lip support with burned plates. All impact forces are absorbed in optimal way avoiding damages and providing long life time.

ASSA ABLOY 950 series - the intelligent, all in one, docking control system

The innovative and unique 950 series docking control system gives you direct control of the dock leveler, dock shelter and door all in one control unit. With only a few self explaining buttons it is easy to operate, to meet the demands of modern logistics. Separate steering units or complex wiring are no longer needed.

ASSA ABLOY DE6090DI Dock-IN

ASSA ABLOY Dock-IN is the world's first combined solution with parking guide and traffic lights in one system. ASSA ABLOY Dock-IN ensures a safe and secure dock in procedure with the help of white guiding lights and red traffic lights. There is no need to paint and repaint guiding lines on the asphalt or install conventional steel parking guides, which are an obstacle in the yard. With modern LED technology ASSA ABLOY Dock-IN has a low energy consumption and a long life.

Technical Data

Sizes – pit length	1765 mm – 3050 mm
Sizes – nominal length	1750 mm – 3000 mm
Sizes – pit width	1730 mm – 2310 mm
Sizes – nominal width	1700 mm – 2250 mm
Leveler height	600, 700 mm
Load capacity	60 kN (6 tonnes)
Vertical working range	
Rise above dock	up to 400 mm
Fall below dock	down to 340 mm
Platform tear-plate thickness	6/8 mm - 8/10 mm
Max. point load leveler platform	1,3 N / mm ² (6 mm tear plate) 6,5 N / mm ² (8 mm tear plate)
Lip material & length	steel, 400 / 500 mm
Control unit protection class	IP 54
Nominal voltage	400V 3-phase, 230V 3-phase
Nominal motor power	0,75 kW
European standard	EN 1398 Dock levelers

Dimensions

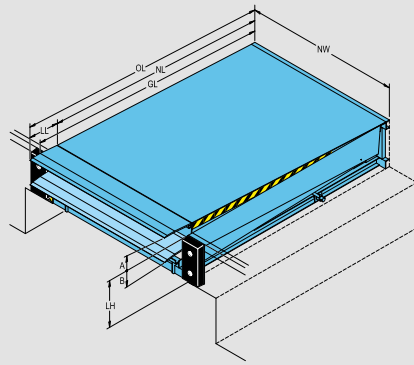

NL	Nominal length
OL	Overall length
GL	Gradient length
NW	Nominal width
LE	Leveler extension
LH	Leveler height
A	Working range above dock level
B	Working range below dock level
DH	Dock height
DW	Door width

Sizes – pit length	1765 mm – 3050 mm
Sizes – nominal length	1750 mm – 3000 mm
Sizes – pit width	1730 mm – 2310 mm
Sizes – nominal width	1700 mm – 2250 mm
Leveler height	600, 700 mm
Vertical working range	
Rise above dock	up to 400 mm
Fall below dock	down to 340 mm

Electrical preparations

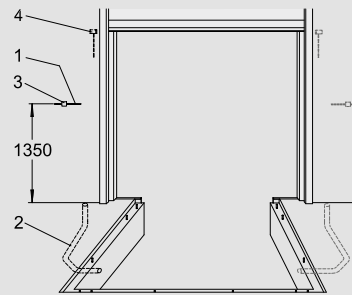

1	Mains supply:	3 / N / PE AC 50 Hz 230 / 400V
	Mains fuse:	D0 10 A gL
	Motor power:	0,75 kW
	Cable:	7 x 0,75 mm ²
	Motor cable:	4 x 1,5 mm ²
2	Conduit for wiring internal diameter	70, angles <45° (by others)
3	Mains isolator*	Only for control box with emergency stop
4	Optional safety switch on sectional door	to disable leveler when door is closed*

*Non standard

Operating functions for swing lip levelers

950 L SD / 950 LA SD



950 DL SD / 950 DLA SD



950 LS SD / 950 LSA SD



950 DLS SD / 950 DLSA SD





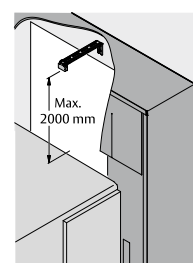
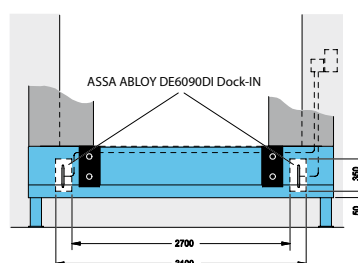
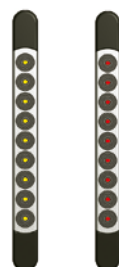

SD = Swingdock
L = Leveler
A = Auto Button
D = Door
S = Shelter

ASSA ABLOY DE6090DI Dock-IN



Standard available colours

	Red RAL 3002		Green RAL 6005		Hot dip galvanised
	Blue RAL 5010		Jet Black RAL 9005		